

ERSATZTEILE UND ZUBEHÖR SPARE PARTS AND ACCESSORIES

O-Ring Set EPDM

Bestehend aus:

- 1x O-Ring für Ventilspindel*
- 1x O-Ring für Ventildeckel
- 1x O-Ring für Konus

O-ring set EPDM

Consists of:

- 1x O-ring for pivoted axle*
- 1x O-ring for bearing cap
- 1x O-ring for cone

O-Ring Set FPM (Viton®)

Bestehend aus:

- 1x O-Ring für Ventilspindel*
- 1x O-Ring für Ventildeckel
- 1x O-Ring für Konus

O-ring set FPM (Viton®)

Consists of:

- 1x O-ring for pivoted axle*
- 1x O-ring for bearing cap
- 1x O-ring for cone

O-Ring Set FEP

Bestehend aus:

- 1x O-Ring für Ventilspindel*
- 1x O-Ring für Ventildeckel
- 1x O-Ring für Konus

O-ring set FEP

Consists of:

- 1x O-ring for pivoted axle*
- 1x O-ring for bearing cap
- 1x O-ring for cone

Für Bogenventile und Molchweichen

For arc valves and pigging valves

EPDM O-Ring Set

EPDM O-ring set

DN			Typ Type
25	25	1"	25SD502S21E
40	38	1½"	38-40SD502S21E
50	51	2"	50-51SD502S21E
	63	2½"	63S502S21E
65	76	3"	65-76SD502S21E
80			80D502S21E
100	102	4"	100-102SD502S21E
150		6"	150D502E

FPM (Viton®) O-Ring Set

FPM (Viton®) O-ring set

DN			Typ Type
25	25	1"	25SD502S21V
40	38	1½"	38-40SD502S21V
50	51	2"	50-51SD502S21V
	63	2½"	63S502S21V
65	76	3"	65-76SD502S21V
80			80D502S21V
100	102	4"	100-102SD502S21V
150		6"	150D502V

FEP O-Ring Set

FEP O-ring set

DN			Typ Type
25	25	1"	25SD502S21FEP
40	38	1½"	38-40SD502S21FEP
50	51	2"	50-51SD502S21FEP
	63	2½"	63S502S21FEP
65	76	3"	65-76SD502S21FEP
80			80D502S21FEP
100	102	4"	100-102SD502S21FEP
150		6"	150D502FEP

* Hinweis:

Bei Bogenventilen mit „Leckageüberwachung der beweglichen O-Ring Dichtung“ sind im O-Ring Set zwei O-Ringe für die Ventilspindel enthalten.

* Please note:

For arc valves with "leakage control of the moving O-ring seal", the O-ring set contains two O-rings for the pivoted axle.

**ERSATZTEILE
UND ZUBEHÖR
SPARE PARTS
AND ACCESSORIES**

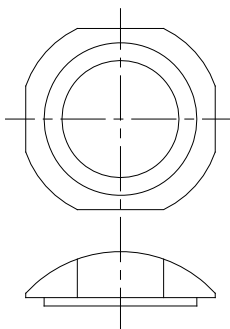
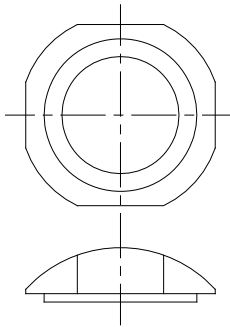
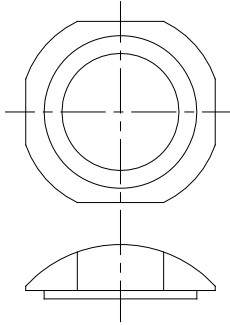

Für Bogenventile und Molchweichen

For arc valves and pigging valves

Dyneon™ TFM1600 Schließer Dyneon™ TFM1600 shutter

DN			Typ Type
25	25	1"	25SD501T
40	38	1½"	38-40SD501T
50	51	2"	50-51SD501T
	63	2½"	63S501T
65	76	3"	65-76SD501T
80			80D501T
100	102	4"	100-102SD501T
150		6"	150D501T

Tecapeek® Schließer Tecapeek® shutter

DN			Typ Type
25	25	1"	25SD501P
40	38	1½"	38-40SD501P
50	51	2"	50-51SD501P
	63	2½"	63S501P
65	76	3"	65-76SD501P
80			80D501P
100	102	4"	100-102SD501P

PTFE+15% Peek PTFE+15 Peek

DN			Typ Type
25	25	1"	25SD501TP
40	38	1½"	38-40SD501TP
50	51	2"	50-51SD501TP
	63	2½"	63S501TP
65	76	3"	65-76SD501TP
80			80D501TP
100	102	4"	100-102SD501TP

**ERSATZTEILE
UND ZUBEHÖR
SPARE PARTS
AND ACCESSORIES**

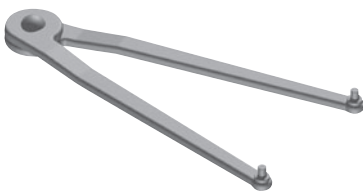
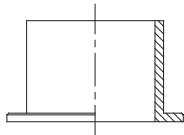
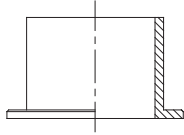

Für Bogenventile und Molchweichen

For arc valves and pigging valves

Lagerbuchse aus POM (Polyacetal) Bearing bush POM (Polyacetal)

DN			Typ Type
25	25	1"	25SD503
40	38	1½"	38-80SD503
50	51	2"	38-80SD503
65	63	2½"	38-80SD503
80	76	3"	38-80SD503
100	102	4"	100-102SD503
150		6"	150SD503

Lagerbuchse aus Dyneon™ TFM1600 Bearing bush Dyneon™ TFM1600

DN			Typ Type
25	25	1"	25SD503T
40	38	1½"	38-80SD503T
50	51	2"	38-80SD503T
65	63	2½"	38-80SD503T
80	76	3"	38-80SD503T
100	102	4"	100-102SD503T

**Stirnlochschlüssel zum Montieren der Anzugsmutter
Assembling tool for the pinching nut**

DN			Typ Type
25	25	1"	25-150SL
40	38	1½"	25-150SL
50	51	2"	25-150SL
65	63	2½"	25-150SL
80	76	3"	25-150SL
100	102	4"	25-150SL
150		6"	25-150SL

ERSATZTEILE UND ZUBEHÖR SPARE PARTS AND ACCESSORIES

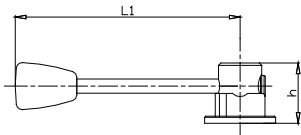

Für Bogenventile For arc valves

Standard Handhebel, 4 x 90° Standard handle, 4 x 90°

DN			L1	h	Typ Type
25	25	1"	160	51	25-40SD506-90
40	38	1½"	160	51	25-40SD506-90
50	51	2"	190	51	50-63SD506-90
	63	2½"	190	51	50-63SD506-90
65	76	3"	190	51	65-80SD506-90
80			190	51	65-80SD506-90
100	102	4"	270	51	100-102SD506-90
150		6"	270	55	150D506-90

Standard Handhebel mit Rückmeldehalter M12, 0° - 90° Standard handle with feedback bracket M12, 0° - 90°

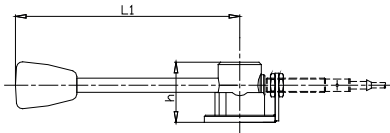

DN			L1	h	Typ Type
25	25	1"	160	51	25-40SD506-90R
40	38	1½"	160	51	25-40SD506-90R
50	51	2"	190	51	50-63SD506-90R
	63	2½"	190	51	50-63SD506-90R
65	76	3"	190	51	65-80SD506-90R
80			190	51	65-80SD506-90R
100	102	4"	270	51	100-102SD506-90R
150		6"	270	55	150D506-90R

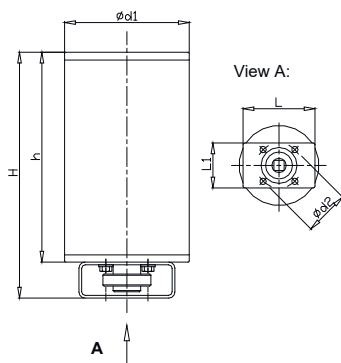

Edelstahlantrieb-Serie KH luftöffnend / federschließend 0° - 90° Stainless steel actuator series KH, air to open / spring to close 0° - 90°

DN			Typ Type	Ø d1	Ø d2	H	h	L	L1
25	25	1"	25-40KH002S	89	50	205	175	80	50
40	38	1½"	25-40KH002S	89	50	205	175	80	50
50	51	2"	50-63KH004S	104	50	205	175	80	50
	63	2½"	50-63KH004S	104	50	205	175	80	50
65-80	76	3"	65-80KH006S	129	50	260	230	80	70
100	102	4"	100-102LKLA*	133	70	258	220	Ø 90	

* Edelstahlantrieb Serie Alfa / Stainless steel actuator series Alfa

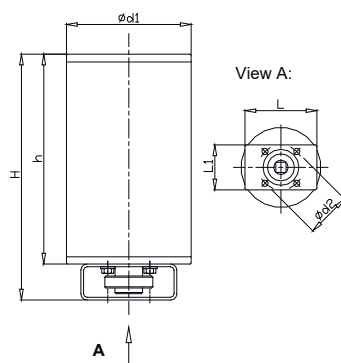

Edelstahlantrieb-Serie KH luftöffnend / luftschließend 0° - 90° Stainless steel actuator series KH, air to open / air to close 0° - 90°

DN			Typ Type	Ø d1	Ø d2	H	h	L	L1
25	25	1"	25-40KH002D	89	50	205	175	80	50
40	38	1½"	25-40KH002D	89	50	205	175	80	50
50	51	2"	50-63KH004D	104	50	205	175	80	50
	63	2½"	50-63KH004D	104	50	205	175	80	50
65-80	76	3"	65-80KH006D	129	50	260	230	80	70
100	102	4"	100-102KH006D	129	70	260	230	80	70

ERSATZTEILE UND ZUBEHÖR SPARE PARTS AND ACCESSORIES

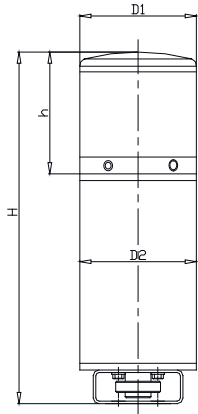

ASi oder DeviceNet auf Anfrage
ASi or DeviceNet upon request

Für Bogenventile For arc valves

Edelstahlantrieb-Serie KH Luft/Feder 0° - 90° mit Steuerkopf TOP Stainless steel actuator series KH, air/spring 0° - 90° with control unit TOP

DN			Typ Type	Ø D1	Ø D2	H	h
25	25	1"	25-40KH002 L/F TOP	102	89	316	111
40	38	1½"	25-40KH002 L/F TOP	102	89	316	111
50	51	2"	50-63KH004 L/F TOP	102	104	316	111
	63	2½"	50-63KH004 L/F TOP	102	104	316	111
65-80	76	3"	65-80KH006 L/F TOP	102	129	371	111
100	102	4"	100-102LKLA-T*	102	133	385	127

* Edelstahlantrieb Serie Alfa / Stainless steel actuator series Alfa

Edelstahlantrieb-Serie KH Luft/Luft 0° - 90° mit Steuerkopf TOP Stainless steel actuator series KH, air/air 0° - 90° with control unit TOP

DN			Typ Type	Ø D1	Ø D2	H	h
25	25	1"	25-40KH002 L/L TOP	102	89	316	111
40	38	1½"	25-40KH002 L/L TOP	102	89	316	111
50	51	2"	50-63KH004 L/L TOP	102	104	316	111
	63	2½"	50-63KH004 L/L TOP	102	104	316	111
65-80	76	3"	65-80KH006 L/L TOP	102	129	371	111
100	102	4"	100-102KH006 L/L TOP	102	129	371	111

**ERSATZTEILE
UND ZUBEHÖR**
**SPARE PARTS
AND ACCESSORIES**

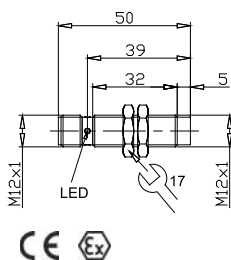
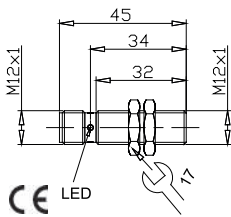
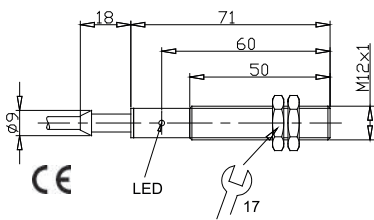
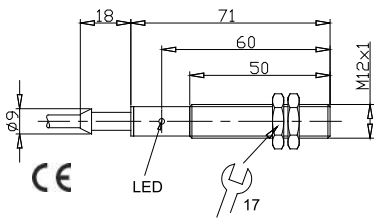

Für Bogenventile For arc valves

**Induktiver Näherungsschalter M12 aus Kunststoff,
24V DC für Antrieb Serie KH und KHG**

**Inductive proximity switch M12, plastic,
24V DC for actuator series KH and KHG**

DN			Typ Type
25	25	1"	25-102M55B
40	38	1½"	25-102M55B
50	51	2"	25-102M55B
65	63	2½"	25-102M55B
80	76	3"	25-102M55B
100	102	4"	25-102M55B

**Induktiver Näherungsschalter M12 aus Kunststoff,
20-250V AC für Antrieb Serie KH und KHG**

**Inductive proximity switch M12, plastic,
20-250V AC for actuator series KH and KHG**

DN			Typ Type
25	25	1"	25-102M55C
40	38	1½"	25-102M55C
50	51	2"	25-102M55C
65	63	2½"	25-102M55C
80	76	3"	25-102M55C
100	102	4"	25-102M55C

**Induktiver Näherungsschalter M12 aus Metall,
24V DC für Antrieb Serie KH und KHG**

**Inductive proximity switch M12, metal,
24V DC for actuator series KH and KHG**

DN			Typ Type
25	25	1"	25-102M55BSt
40	38	1½"	25-102M55BSt
50	51	2"	25-102M55BSt
65	63	2½"	25-102M55BSt
80	76	3"	25-102M55BSt
100	102	4"	25-102M55BSt

**Induktiver Näherungsschalter M12 aus Metall,
8,2V DC für Antrieb Serie KH und KHG, Ex**

**Inductive proximity switch M12, metal,
8,2V DC for actuator series KH and KHG, Ex**

DN			Typ Type
25	25	1"	25-102M55ExSt
40	38	1½"	25-102M55ExSt
50	51	2"	25-102M55ExSt
65	63	2½"	25-102M55ExSt
80	76	3"	25-102M55ExSt
100	102	4"	25-102M55ExSt

ERSATZTEILE UND ZUBEHÖR SPARE PARTS AND ACCESSORIES

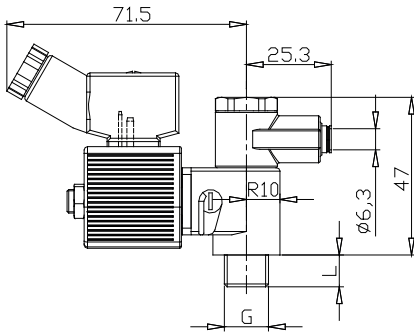

Bestehend aus (für Serie KH):
8 x O-Ring aus NBR
1 x Kolbendichtring

Consists of:
8 x O-Ring NBR
1 x Piston seal

Für Bogenventile For arc valves

3/2 Magnetventil mit Gerätesteckdose, für Edelstahltrieb-Serie KH 3/2 Solenoid valve with cable plug, for stainless steel actuator series KH

DN			Typ Type		G	L
25	25	1"	25-63MVB24D	24V DC	G 1/8	6,5
			25-63MVB110A	110V AC		
			25-63MVB230A	230V AC		
40	38	1½"	25-63MVB24D	24V DC	G 1/8	6,5
			25-63MVB110A	110V AC		
			25-63MVB230A	230V AC		
50	51	2"	25-63MVB24D	24V DC	G 1/8	6,5
			25-63MVB110A	110V AC		
			25-63MVB230A	230V AC		
	63	2½"	25-63MVB24D	24V DC	G 1/8	6,5
			25-63MVB110A	110V AC		
			25-63MVB230A	230V AC		
65-80	76	3"	65-102MVB24D	24V DC	G 1/4	9,5
			65-102MVB110A	110V AC		
			65-102MVB230A	230V AC		
100	102	4"	65-102MVB24D	24V DC	G 1/4	9,5
			65-102MVB110A	110V AC		
			65-102MVB230A	230V AC		

Dichtungssatz für Edelstahltrieb-Serie KH und Serie Alfa Gasket set for stainless steel actuator series KH and Alfa

DN			Typ Type	
25	25	1"	25-40KH002 DS	
40	38	1½"	25-40KH002 DS	
50	51	2"	50-63KH004 DS	
	63	2½"	50-63KH004 DS	
65-80	76	3"	65-102KH006 DS	
100	102	4"	65-102KH006 DS	
100	102	4"	65-102LKLASK*	

* Dichtungssatz für Edelstahltrieb Serie Alfa / Gasket set for stainless steel actuator series Alfa

ERSATZTEILE UND ZUBEHÖR SPARE PARTS AND ACCESSORIES

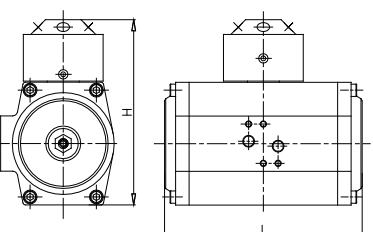
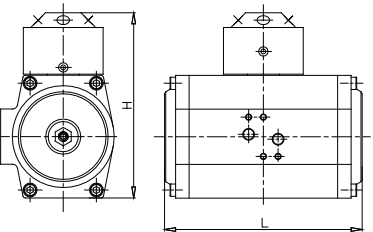
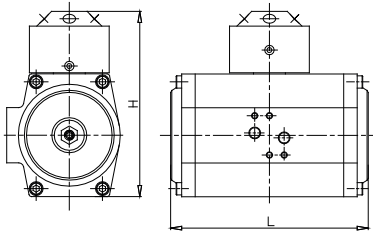
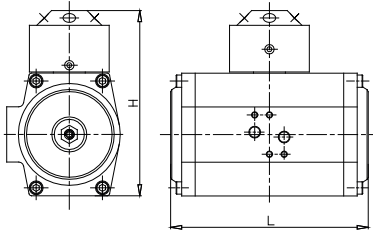

Für Bogenventile For arc valves

Pneumatiktrieb mit Aluminiumgehäuse Serie B, luftöffnend/luftschließend, 0° - 90°
Pneumatic actuator with aluminium housing series B, air to open/air to close, 0° - 90°

	DN		L	H	Typ Type	
	25	25	1"	161	151	25-63KB50
	40	38	1½"	161	151	25-63KB50
	50	51	2"	161	151	25-63KB50
		63	2½"	161	151	25-63KB50
	65 - 80	76	3"	209	168	65-80KB50
	100	102	4"	209	168	100-102KB50
	150		6"	333	187	150KA50

Gehäuse mit PTFE Beschichtung auf Anfrage / PTFE coated housing upon request

Pneumatiktrieb mit Aluminiumgehäuse Serie B, luftöffnend/federschließend, 0° - 90°
Pneumatic actuator with aluminium housing series B, air to open/spring to close, 0° - 90°

	DN		L	H	Typ Type	
	25	25	1"	161	151	25KB51
	40	38	1½"	180	159	38-51KB51
	50	51	2"	180	159	38-51KB51
		63	2½"	209	168	63-76KB51
	65	76	3"	209	168	63-76KB51
	80			222	191	80KB51
	100	102	4"	222	191	100-102KB51

Gehäuse mit PTFE Beschichtung auf Anfrage / PTFE coated housing upon request

Pneumatiktrieb mit Aluminiumgehäuse Serie B, luftöffnend/luftschließend, 0° - 180°
Pneumatic actuator with aluminium housing series B, air to open/air to close, 0° - 180°

	DN		L	H	Typ Type	
	25	25	1"	235	151	25-63KB180
	40	38	1½"	235	151	25-63KB180
	50	51	2"	235	151	25-63KB180
		63	2½"	235	151	25-63KB180
	65 - 80	76	3"	311	168	65-80KB180
	100	102	4"	311	168	100-102KB180
	150		6"	448	211	150KB180

Gehäuse mit PTFE Beschichtung auf Anfrage / PTFE coated housing upon request

Dreipositions-Pneumatiktrieb mit Aluminiumgehäuse Serie B, luftöffnend/luftschließend, 0° - 90° - 180°
3-position operation pneumatic actuator with aluminium housing series B, air to open/air to close, 0° - 90° - 180°

	DN		L	H	Typ Type	
	25	25	1"	344	151	25-63KB52
	40	38	1½"	344	151	25-63KB52
	50	51	2"	344	151	25-63KB52
		63	2½"	344	151	25-63KB52
	65 - 80	76	3"	434	168	65-80KB52
	100	102	4"	434	168	100-102KB52
	150		6"	631	211	150KB52

Gehäuse mit PTFE Beschichtung auf Anfrage / PTFE coated housing upon request

ERSATZTEILE UND ZUBEHÖR SPARE PARTS AND ACCESSORIES

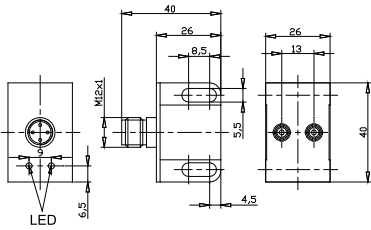

CE

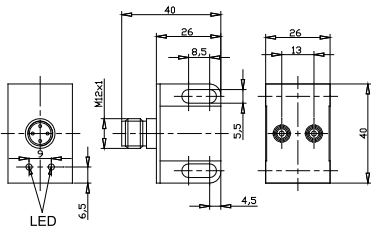

CE

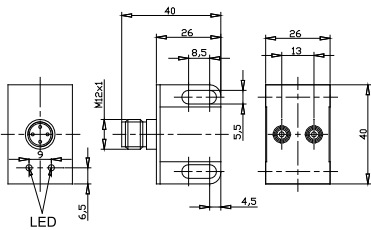

CE Ex

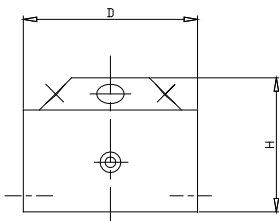

Für Bogenventile For arc valves

Induktiver Näherungsschalter (Doppelsensor), 24V DC für Pneumatiktrieb Serie B
Inductive proximity switch (double sensor), 24V DC for pneumatic actuator series B

DN			Typ Type
25	25	1"	25-102M55
40	38	1½"	25-102M55
50	51	2"	25-102M55
65	63	2½"	25-102M55
80	76	3"	25-102M55
100	102	4"	25-102M55
150		6"	25-102M55

Induktiver Näherungsschalter (Doppelsensor), 20-250V AC für Pneumatiktrieb Serie B
Inductive proximity switch (double sensor), 20-250V AC for pneumatic actuator series B

DN			Typ Type
25	25	1"	25-102M55A
40	38	1½"	25-102M55A
50	51	2"	25-102M55A
65	63	2½"	25-102M55A
80	76	3"	25-102M55A
100	102	4"	25-102M55A
150		6"	25-102M55A

Induktiver Näherungsschalter (Doppelsensor), 8,2V DC für Pneumatiktrieb Serie B, Ex
Inductive proximity switch (double sensor), 8,2V DC for pneumatic actuator series B, Ex

DN			Typ Type
25	25	1"	25-102M55AT
40	38	1½"	25-102M55AT
50	51	2"	25-102M55AT
65	63	2½"	25-102M55AT
80	76	3"	25-102M55AT
100	102	4"	25-102M55AT
150		6"	25-102M55AT

Schaltnocken für Pneumatiktrieb Serie B, 0° - 90° (180°)
Target puck for pneumatic actuator series B, 0° - 90° (180°)

DN			Ø D	H	Typ Type
25	25	1"	65	50	25-150SN65
40	38	1½"	65	50	25-150SN65
50	51	2"	65	50	25-150SN65
65	63	2½"	65	50	25-150SN65
80	76	3"	65	50	25-150SN65
100	102	4"	65	50	25-150SN65
150		6"	65	50	25-150SN65

5

ERSATZTEILE UND ZUBEHÖR SPARE PARTS AND ACCESSORIES



Bestehend aus:
2 x 5/2 Magnetventil
1 x Adapterplatte
inkl. komplette Verschlauchung

Consists of:
2 x 5/2 solenoid valve
1 x mounting plate
incl. complete tubing

Für Bogenventile For arc valves

5/2 Magnetventil mit Gerätesteckdose für Pneumatiktrieb mit Aluminiumgehäuse Serie B

5/2 Solenoid valve with cable plug for pneumatic actuator with aluminium housing series B

DN			Typ Type		
25	25	1"	25-102MVA24D	24V DC	G 1/4
			25-102MVA115A	115V AC	
			25-102MVA230A	230V AC	
40	38	1½"	25-102MVA24D	24V DC	G 1/4
			25-102MVA115A	115V AC	
			25-102MVA230A	230V AC	
50	51	2"	25-102MVA24D	24V DC	G 1/4
			25-102MVA115A	115V AC	
			25-102MVA230A	230V AC	
	63	2½"	25-102MVA24D	24V DC	G 1/4
			25-102MVA115A	115V AC	
			25-102MVA230A	230V AC	
65-80	76	3"	25-102MVA24D	24V DC	G 1/4
			25-102MVA115A	115V AC	
			25-102MVA230A	230V AC	
100	102	4"	25-102MVA24D	24V DC	G 1/4
			25-102MVA115A	115V AC	
			25-102MVA230A	230V AC	

Steuerventilblock für Dreipositions-Pneumatiktrieb mit Aluminiumgehäuse Serie B

Steering unit for 3-position operating pneumatic actuator with aluminium housing series B

DN			Typ Type		
25	25	1"	25-102STV24D	24V DC	G 1/4
			25-102STV115A	115V AC	
			25-102STV230A	230V AC	
40	38	1½"	25-102STV24D	24V DC	G 1/4
			25-102STV115A	115V AC	
			25-102STV230A	230V AC	
50	51	2"	25-102STV24D	24V DC	G 1/4
			25-102STV115A	115V AC	
			25-102STV230A	230V AC	
	63	2½"	25-102STV24D	24V DC	G 1/4
			25-102STV115A	115V AC	
			25-102STV230A	230V AC	
65-80	76	3"	25-102STV24D	24V DC	G 1/4
			25-102STV115A	115V AC	
			25-102STV230A	230V AC	
100	102	4"	25-102STV24D	24V DC	G 1/4
			25-102STV115A	115V AC	
			25-102STV230A	230V AC	

ERSATZTEILE UND ZUBEHÖR SPARE PARTS AND ACCESSORIES

Bestehend aus:
2 x Kolben-Führungsring
2 x Führungssegment
1 x Gleitring „oben“
1 x Gleitring „unten“

Consists of:
2 x piston guiding ring
2 x guiding segment
1 x slip ring "top"
1 x slip ring "bottom"

Bestehend aus:
2 x Deckeldichtung
2 x O-Ring „Kolben“
2 x O-Ring „Antriebsritzel“
2 x O-Ring „Einstellschraube“
1 x O-Ring „innere
Endlageneinstellung“

Consists of:
2 x gasket for cap
2 x O-ring "piston"
2 x O-ring "drive pinion"
2 x O-ring "adjusting screw"
1 x O-ring "inside end
position adjustment"

Ohne Bild / without picture

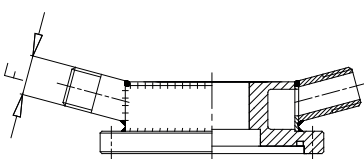

Für Bogenventile For arc valves

Verschleißteilesatz für Pneumatiktrieb Serie B Set of wearing parts for pneumatic actuator series B

DN			Typ Type
25	25	1"	25-63W
40	38	1½"	25-63W
50	51	2"	25-63W
	63	2½"	25-63W
65-80	76	3"	65-102W
100	102	4"	65-102W

O-Ring Set für Pneumatiktrieb Serie B O-ring set for pneumatic actuator series B

DN			Typ Type
25	25	1"	25-63OR
40	38	1½"	25-63OR
50	51	2"	25-63OR
	63	2½"	25-63OR
65-80	76	3"	65-102OR
100	102	4"	65-102OR

Elektropneumatischer Stellungsregler für Pneumatiktrieb Serie B, 4-20mA / 24V DC Electropneumatic positioner for pneumatic actuator series B, 4-20mA / 24V DC

DN			Typ Type
25	25	1"	25-102SBE
40	38	1½"	25-102SBE
50	51	2"	25-102SBE
65	63	2½"	25-102SBE
80	76	3"	25-102SBE
100	102	4"	25-102SBE
150		6"	150SBE

Beheizbarer Ventildeckel (Wasser/Dampf) Heated bearing cap (water/steam)

DN			F	Typ Type
25	25	1"	G 1/8	25SD505H
40	38	1½"	R 1/2	38-40SD505H
50	51	2"	R 1/2	50-51SD505H
	63	2½"	R 1/2	63S505H
65	76	3"	R 1/2	65-76SD505H
80			R 1/2	80D505H
100	102	4"	R 1/2	100-102SD505H
150		6"	R 1/2	150D505H a.A. upon request

ERSATZTEILE UND ZUBEHÖR SPARE PARTS AND ACCESSORIES

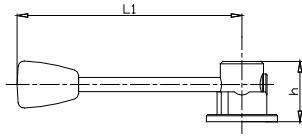

Für Molchweichen For pigging valves

Standard Handhebel, 3 x 120° Standard handle, 3 x 120°

	DN		L1	h	Typ Type
40	38	1½"	160	51	38-40SD506-120
50	51	2"	190	51	50-63SD506-120
	63	2½"	190	51	50-63SD506-120
65	76	3"	190	51	65-80SD506-120
80			190	51	65-80SD506-120
100	102	4"	270	51	100-102SD506-120

Standard Handhebel mit Rückmeldehalter M12, 0° - 120° Standard handle with feedback bracket M12, 0° - 120°

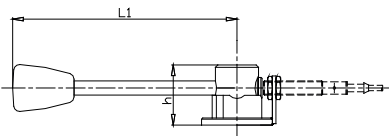

	DN		L1	h	Typ Type
40	38	1½"	160	51	38-40SD506-120R
50	51	2"	190	51	50-63SD506-120R
	63	2½"	190	51	50-63SD506-120R
65	76	3"	190	51	65-80SD506-120R
80			190	51	65-80SD506-120R
100	102	4"	270	51	100-102SD506-120R

Pneumatiktrieb mit Aluminiumgehäuse Serie B, luftöffnend / luftschießend, 0° - 120° Pneumatic actuator with aluminium housing series B, air to open / air to close, 0° - 120°

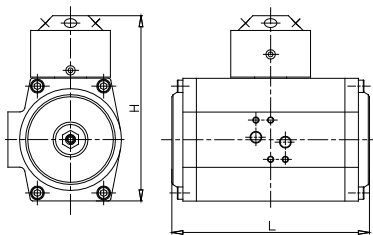

	DN		L	H	Typ Type
40	38	1½"	182	157	38-63KB50V
50	51	2"	182	157	38-63KB50V
	63	2½"	182	157	38-63KB50V
65 - 80	76	3"	236	174	65-80KB50V
100	102	4"	236	174	100-102KB50V

Gehäuse mit PTFE Beschichtung auf Anfrage / PTFE coated housing upon request

Dreipositions-Pneumatiktrieb mit Aluminiumgehäuse Serie B, luftöffnend / luftschießend, 0° - 120° - 240° 3-position pneumatic actuator with aluminium housing series B, air to open / air to close, 0° - 120° - 240°

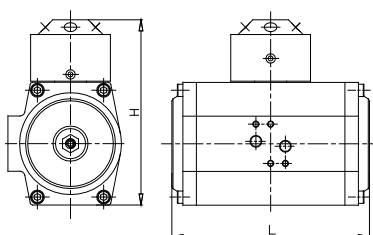

	DN		L	H	Typ Type
40	38	1½"	410	157	38-63KB52V
50	51	2"	410	157	38-63KB52V
	63	2½"	410	157	38-63KB52V
65 - 80	76	3"	518	174	65-80KB52V
100	102	4"	518	174	100-102KB52V

Gehäuse mit PTFE Beschichtung auf Anfrage / PTFE coated housing upon request